

# User Manual



Language: English  
Version: V 2020.12.03

## Copyright Declaration

No unit or individual may extract, compile, translate or reproduce any contents of this manual (eg: technical documentation, software, etc.), nor disseminate in any form (including materials and publications) without the written permission of Shenzhen Elephant Robotics Technology Co., Ltd. (hereinafter referred to as "Elephant Robotics").

In addition, the product information and related resources mentioned in this manual are for reference only and the contents are subject to change without notice.

Except as expressly stated in this manual, nothing in this manual should be construed as any warranty or guarantee by the Elephant Robotics of personal loss, damage to property, or fitness for a particular purpose.

All rights reserved!

# Overview

## About the manual

---

Welcome to use MyCobot collaborative robot and thank you for your purchase. This manual describes the precautions for proper installation and use of MyCobot . Please read this manual and other related manuals carefully before installing this robot system. After reading, please keep it in a safe place so that you can access it at any time.

## Reading objects of the manual

---

This manual is targeted to:

- installer.
- Debugger.
- Maintenance staff.



Attention

Those who install/debug/maintain the MyCobot collaborative robot must be trained in Elephant Robotics and have the mechanical and electronic knowledge required for the above work.

## How to use

---

This manual should be used when doing the following works:

- Installation work: Move the robot to the working position and fix it to the base according to the installation instructions.
- Debugging: Debugging the robot to work status.
- Maintenance work: regular maintenance robot system to ensure its normal functioning. When the robot malfunctions due to environmental influences or improper operation of the user, or a certain component of the robot system exceeds the normal service life, the robot needs to be repaired.

**Note:** This manual is applicable to international users, as well as users in Hong Kong, Macao and Taiwan.

## Content

About the manual.....	3
<b>1. Security.....</b>	<b>5</b>
1.1 Hazard Identification.....	5
1.2 Safety Precautions.....	6
1.3 Usage scenarios.....	7
<b>2. About myCobot.....</b>	<b>7</b>
2.1 Background.....	7
2.2 Introduction.....	7
2.3 Features.....	8
<b>3. Hardware.....</b>	<b>7</b>
3.1 Controller and Actuator.....	9
3.2 Mechanical Structure.....	12
3.3 Electronics and Electrical.....	15
<b>4. Software.....</b>	<b>16</b>
4.1 Built-in Track Recording.....	16
4.2 Arduino Libraries.....	17
4.3 API Interface and Communication.....	19
4.4 ROS.....	19
4.5 Joint Calibration.....	19
4.6 Firmware Upgrade and Recovery.....	19
<b>5. Visual Programming and Industrial Software.....</b>	<b>21</b>
5.1 Visual Programming Software-UIFlow.....	21
5.2 Industrial Visualization Programming Software-RoboFlow.....	21
<b>6. After-sales Service.....</b>	<b>21</b>
<b>7. Question &amp; Answer.....</b>	<b>23</b>
<b>8. Contact Us.....</b>	<b>23</b>

# 1. Security

This chapter details general safety information for people who perform installation, maintenance, and repair work on the robots. Please read and understand the contents and precautions of this chapter before handling, installation and use.

## 1.1 Hazard Identification

The safety of the collaborative robot is based on the premise of proper configuration and use of the robot, and even if all safety instructions are observed, the injury or damage caused by the operator may still occur. Therefore, it is very important to understand the safety hazards of robot use, which is beneficial to prevent problems before they occur.

Tables 1-2~4 below are common safety hazards that may exist in the context of using robots:

Table1- 2 Dangerous safety hazards

 Danger	
1	Personal injury or robot damage caused by incorrect operation during robot handling.
2	Personal injury or robot damage caused because the robot is not fixed as required, for example, the screw is not screwed or tightened, and the base is not enough to stably support the robot for high-speed movement, causing the robot to tip down.
3	Failure to perform proper safety function configuration of the robot, or installation of safety protection tools, etc., may cause the safety function of the robot to fail.

Table1- 3 Warning level security risks



 Warning	
1	Play around the robot, you may be hit by a running robot, or be tripped by an obstacle such as a cable to cause personal injury.
2	Unauthorized personnel change the security configuration parameters, causing the safety function to fail or danger.
3	Scratches and punctures caused by sharp surfaces such as other devices in the work environment or robot end effector.
4	The robot is a precision machine and pedaling may cause damage to the robot.
5	If the clamp is not in place or before the power supply of the robot is turned off or the gas source is turned off (it is not determined whether the end effector firmly holds the object without falling off due to loss of power). If the clamped object is not removed, it may cause danger, such as people being injured by crashing.
6	There is a risk of accidental movement of the robot. Under no circumstances should you stand under any axis of the robot!
7	The robot is a precision machine. If it is not placed smoothly during handling, it may cause vibration and may cause damage to the internal components of the robot.

Table1- 4 Potential safety hazards that may result in electric shock

 Caution Electricity	
1	Using a non-original cable may pose an unknown hazard.
2	Contact with liquids by electrical equipment may result in a risk of electric leakage.
3	There may be an electric shock hazard when the electrical connection is incorrect.
4	Be sure to handle replacement work after turning off the power to the controller and related equipment and unplugging the power cord. If the work is performed while the power is on, it may cause electric shock or malfunction.

## 1.2 Safety Precautions

**The following security rules should be followed when using myCobot:**

- myCobot is electrical equipment. Non-professional technicians cannot modify the wire, otherwise it is vulnerable to injure the device or the person.
- The DANGER, WARNING marks in this manual are only supplemental to the security precautions.
- Please use myCobot in the specific environment scope. If not, exceeding the specifications and load conditions will shorten the service life of the product even damage the equipment.
- Before operating and maintaining myCobot, the personnel responsible for the installation, operation and maintenance must be trained to understand the various security precautions and to the correct methods of operation and maintenance.
- Do not use myCobot in damp environment for a long time in order to avoid damage, myCobot belongs to precision electronic components.
- Do not use myCobot in high temperature environment. The outer surface of myCobot is made of photosensitive resin as raw material, high temperature will damage the shell and lead to failure.
- Highly corrosive cleaning is not suited to cleaning myCobot. The anodized components are not suitable for immersion cleaning.
- Do not use myCobot without mounting base to avoid damage to the equipment or accidents. myCobot should be used in a fixed and unobtrusive environment.
- Do not use other power adapters to supply power to myCobot. If it is damaged due to the use of non-conforming adapter, it will not be included in after-sales service.
- Please do not disassemble or unscrew the screws and its shell. If it's opened, no warranty service can be provided.
- People cannot repair myCobot without professional training. If there is a problem with myCobot, please contact myCobot technical support engineer in time.
- Please comply with the relevant laws to deal with scrapped myCobot, and protect the environment.
- DO NOT let children play with myCobot alone. All processes need to be monitored while running. After processes have finished, please turn off the equipment promptly.
- It is prohibited to modify or remove the nameplates, instructions, icons and marks on the robotic arm and the related equipment.
- Do not burn other product drivers to the terminal Atom. If the device is damaged because of that, it will not be included in the after-sales service.

**Please do not use the Catbot collaborative robot for the following purposes.**

- Medical and life-critical applications.
- In environment that may cause an explosion.
- Used directly without risk assessment.
- Insufficient use of safety function levels.
- Inconsistent use of robot performance parameters.

If you have any question about this manual please visit and submit your feedback on:  
<https://www.elephantrobotics.cn>.

### 1.3 Usage scenarios

		PC	Basic	Atom
Development Difficulty				
1	<b>Built-in recording system</b> No programming needed	Don't need	Default Program Basic Main-Control	Standard Hardware Do Not Override
2	<b>UI FLOW</b> Blocky Programming	M5 UIFLOW Online-Programming	UIFLOW Burnprocess Provide by M5	Standard Hardware Do Not Override
3	<b>RoboFlow Professional</b> Blocky programming	RoboFlow Library	Transponder	Standard Hardware Do Not Override
4	<b>MAKER</b> Programming needed	Arduino IDE + M5Stack Library +MycobotBasic Lib	Programs custom 1 SimpleTest 2 SimpleRun	Standard Hardware Do Not Override
4	<b>PC API</b> Programming needed	Python/ C++/ Java	Transponder	Standard Hardware Do Not Override
5	<b>ROS Development</b> Deep Development	ROS Library	Transponder	Standard Hardware Do Not Override

## 2. About myCobot

### 2.1 Background

Upholding the mission of "Enjoy Robots World", Elephant Robotics designed and developed myCobot, the world's smallest and lightest collaborative robot, retaining most of the functions of industrial robots. With compact and elegant industrial design, excellent and powerful performance, and huge software and hardware development space, myCobot has unlimited possibilities in application expansion.

The design prototype of myCobot is from All-in-one Robot launched by Elephant Robot in China in 2018. As the first integrated collaborative robot in China, it has won the 2019 CAIMRS Industrial Robot Innovation Award and 2019 High-tech Robot Annual "Innovation Technology Award", and has been also sold to more than 30 countries at home and abroad, receiving unanimous praise and recognition from the factories of the world's top 500 enterprises.

### 2.2 Introduction

myCobot is the world's smallest and lightest six-axis collaborative robot, jointly produced by Elephant Robotics and M5Stack. It is more than a productivity tool full of imaginations, can carry on the secondary development according to the demands of users to achieve personalized customization.

With a weight of 850g, a payload of 500g and an arm length of 350mm, myCobot is compact but powerful, can not only be matched with a variety of end effectors to adapt to different kinds of application scenarios also support the secondary development of multi-platform software to meet the needs of various scenarios such as scientific research and education, smart home, light industry and commercial applications.

**myCobot - Basic Parameter**

Degree of Freedom	6
Degree of Freedom	500g (long range) , 1000g (short range)
Arm span	350mm
Working radius	280mm
Repeatability	±0.2mm
Weight	850g
Power Input	8V,5A
Working Condition	-5°~45°
Communication	USB Type-C

## 2.3 Features

- **Unique Industrial Design & Extremely Compact**

myCobot is an integrated modular design and only weighs 850g which is very easy to carry. Its overall body structure is compact with less spare parts and can be quickly disassembled and replaced to realize plug and play.

- **High configuration & Equipped with 2 Screens**

myCobot contains 6 high-performance servo motors with fast response, small inertia and smooth rotation. The body carries 2 display screens supporting fastLED library to show the expanded application scene more easily and clearly.

- **Lego Connector & Thousands of M5 Ecological Application**

The base and end of myCobot are equipped with Lego Connector, which is suitable for the development of various miniature embedded equipment. Its base is controlled by M5 Stack Basic, and thousands of application cases can be use directly.

- **Bloky Programming & Supporting Industrial ROS**

Using UIFlow visual programming software, programming myCobot is simple and easy for everyone. You can also use RoboFlow, software of industrial robots from Elephant Robotics, supporting multiple functional modules Arduino + ROS open source system.

- **Track Recording & Learn by hand**

Get rid of the traditional point saving mode, myCobot supports drag trial teaching to record the saved track and can save up to 60mins different Tracks making it easy and fun for new players to learn.

## 2.4 Patents

**Related Patents about myCobot**

No.	Certificate No.	Patent Name	Patent No.	Patentee
1	No.8194138	Mechanical arm linkage and mechanical arm	ZL 2018 20017484.4	Elephant Robotics
2	No.8186088	Mechanical arm joint connector and mechanical arm	ZL 2017 21700594.2	Elephant Robotics



No.	Product	Patent Type	Title	Patent No.
1	Lightweight robotic arm	Appearance patent	Collective Robot Arm	2020030683471.3

No.	Invention title	Application Number
1	Method and system for robot posture maintaining, dragging and teaching	ZL 2018 1 1634649.3
2	A robot online collision detection method and system based on momentum model	ZL 2019 1 0030748.9
3	A Kind of Robot Dynamic Parameter Identification Method Independent of Joint Angular Acceleration	ZL 2019 1 0773865.4



## 3. Hardware

### 3.1 Controller and Actuator

#### 3.1.1 M5Stack Basic Main Controller

**M5Stack BASIC Kit**, like its namesake, is a starter kit among the M5Stack development kit series. It's a modular, stackable, scalable, and portable device which is powered with an ESP-32 core, which makes it open source, low cost, full-function, and easy for developers to handle new product development on all stages including circuit design, PCB design, software, mold design and production. This Basic kit provides a friendly price and full-featured resources which makes it a good starter kit for you to explore IoT.

If you want to explore the fastest way of IoT prototyping, M5Stack development board is the perfect solution. Not like others, M5Stack development board is highly efficient, covered with industrial grade case and **ESP32-based** development board. It integrates with Wi-Fi & Bluetooth modules and contains a dual-core and 16MB of SPI Flash. Together with 30+ M5Stack stackable modules, 40+ extendable units and different levels of program language, you can create and verify your IoT product in a very short time.

Supportive development platforms and programming languages: Arduino, Blockly language with UIFlow, Micropython. Regardless of what level programming skill you have, M5Stack would guide you in every step of the way to realize your idea as well as to the final productization. If you ever played with ESP8266, you would realize that ESP32 is a perfect upgrade out of ESP8266. In comparison, ESP32 has more GPIOs, more analog inputs and two analog outputs, multiple extra peripherals (like a spare UART). Official developing platform ESP-IDF has transplanted with FreeRTOS. With dual-core and real time OS you can get more organized code and much high-speed processor.

M5Stack Basic is consist with two separable parts. The upside part has all kinds of processors, chips, and some other slot components. The bottom part has a lithium battery, M-BUS socket, and extendable pins on both sides.

### 3.1.1.1 Power on/off

- Power on: click the red power button on the left
- Power off: Quickly double-click the red power button on the left

### 3.1.1.2 Product Features

- ESP32-based
- Built-in Speaker, Buttons, Color LCD, Power/Reset button
- TF card slot (16G Maximum size)
- Magnetic suction at back
- Extendable Pins & Holes
- M-Bus Socket & Pins
- Program Platform: UIFlow, MicroPython, Arduino

### 3.1.1.3 Parameter

Resources	Parameter
ESP32-D0WDQ6	240MHz dual core, 600 DMIPS, 520KB SRAM, Wi-Fi, dual mode Bluetooth
Flash	16MB
Powe Input	5V @ 500mA
Port	TypeC x 1, GROVE(I2C+I/O+UART) x 1
Core Bottom Port	PIN (G1, G2, G3, G16, G17, G18, G19, G21, G22, G23, G25, G26, G35, G36)
IPS Screen	2 inch, 320x240 Colorful TFT LCD, ILI9342C, Brightness853nit
Speaker	1W-0928
Button	Custom button x 3
Battery	110mAh @ 3.7V
Antenna	2.4G 3D Antenna
Operating Temperature	32°F to 104°F (0°C to 40°C)
Net Weight	47.2g

Gross weight	93g
Product Size	54 x 54 x 18mm
Package Size	95 x 65 x 25mm
Case material	Plastic (PC)

### 3.1.2 M5Stack Atom

**ATOM Matrix**, which has a size of only 24\*24mm, is the most compact development board in the M5Stack development kit series. It provides more GPIO pins and is very suitable for handy and miniature embedded device development.

The main control adopts the ESP32-PICO-D4 chip, which comes integrated with Wi-Fi and Bluetooth technologies and has 4MB of integrated SPI flash memory. The Atom board provides an Infra-Red LED along with the 5 \* 5 RGB LED matrix on the panel, a built-in IMU sensor (MPU6886), and a HY2.0 interface. A general-purpose programmable button is providing below the RGB Led matrix to enable users to add input support to their various projects. The on-board USB interface (Type-C) enables rapid program uploading and execution. One M2 screw hole is provided on the back for mounting the board.

**Note:** When using the manipulator, please avoid burning the firmware to ATOM at the end of the manipulator. The device only supports our original firmware.

Please kindly understand the inconvenience brought to you.

#### 3.1.2.1 Features

- ESP32 PICO-based
- Programmable button
- 5\*5 RGB LED matrix panel (WS2812C)
- Built-in Infra-red LED
- Built-in MPU6886 Inertial Sensor
- Extendable Pins & Holes
- Program Platform: Arduino UIFlow

#### 3.1.2.2 Specification

Resources	Parameter
ESP32	240MHz dual core, 600 DMIPS, 520KB SRAM, Wi-Fi, dual mode Bluetooth
Flash	4MB
Power Input	5V @ 500mA
Port	TypeC x 1, GROVE(I2C+I/O+UART) x 1
PIN Interface	G19, G21, G22, G23, G25, G33
RGB LED	WS2812C 2020 x 25
MEMS	MPU6886
IR	Infrared transmission
Button	Custom bottom x 1
Antenna	2.4G 3D Antenna

Operating Temperature	32°F to 104°F (0°C to 40°C)
Net weight	3g
Gross weight	14g
Product size	24 x 24 x 14 mm
Package size	24 x 24 x 14 mm
Case material	Plastic (PC)

### 3.1.3 Servo Motor

myCobot shares 6 high-performance servo servos in 6 joints with the advantages of fast response, small inertia, smooth rotation, stable torque, etc.

Resources	Parameter
Size	23.2*12.1*28.5mm
Power input	4.8~7.4V
Operating Temperature	-15~70°
Rated torque	1.5kg.cm@6V
Stall torque	4.5kg.cm@6V
Rotation angle	300° (Angle can be limited by software)

## 3.2 Mechanical Structure

### 3.2.1 Size and working range

#### A) Robotic Arm

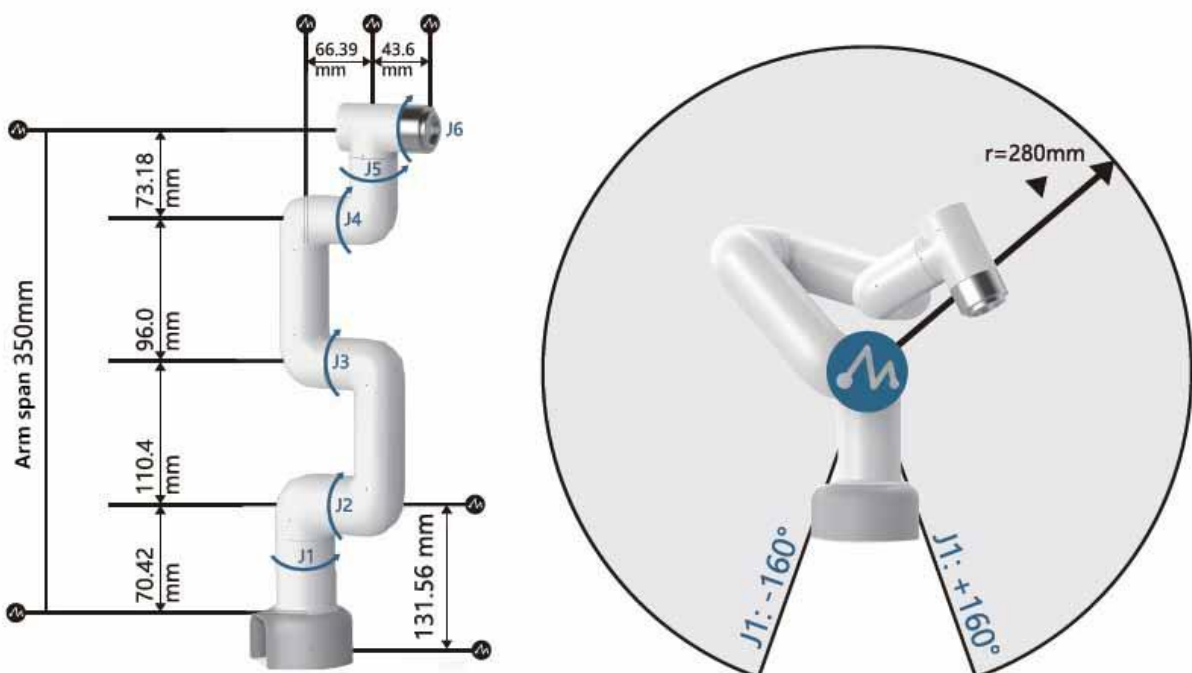

J1	-165 ~ +165	J3	-165 ~ +165	J5	-165 ~ +165
J2	-165 ~ +165	J4	-165 ~ +165	J6	-175 ~ +175

**B) Base Assembly**

The base is compatible with both Lego-tech component holes and through-hole screw holes.

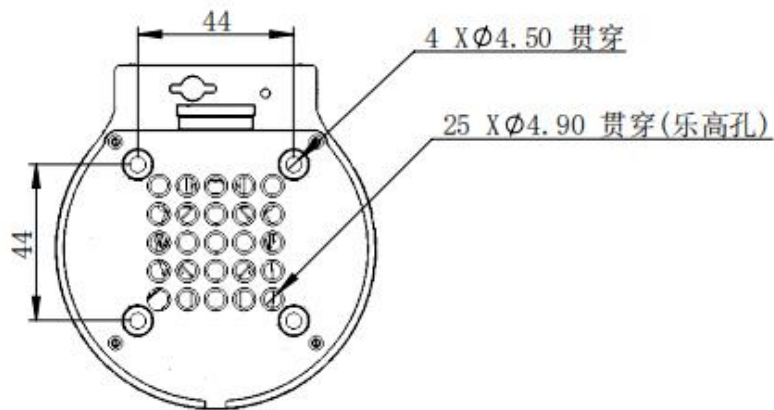

**C) End Assembly**

The end is compatible with both the Lego-tech component hole and the screw thread.

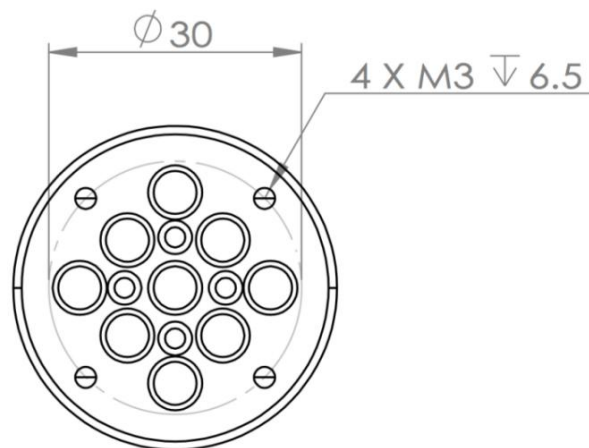

**3.2.2 Unpacking and Installation**

**3.2.2.1 Unpacking**

**Note:** After the packaging box is in place, please confirm that the robot packaging is intact and undamaged. If there is any damage, please contact the logistics company and the local supplier in time. After unpacking, please check the actual items in the box according to the item list.

**myCobot 【standard set】**

myCobot 【standard set】	<ul style="list-style-type: none"> <li>-myCobot-500</li> <li>-Brochure</li> <li>-Power Supply</li> <li>-USB-Type C</li> <li>-Jumper</li> </ul>
------------------------	--

Please install the robot system in an environment that meets the conditions described in the table in order to exert and maintain the performance of the machine and use it safely.

<b>Operating Environment and Conditions</b>	
Temperature	-10°C~45°C
Relative humidity	20%~70%
Indoor/Outdoor	Indoor
Another Environmental requirement	-Avoid sunlight. -Keep away from dust, oily smoke, salt, iron filings, etc. -Keep away from flammable and corrosive liquids and gases. -Do not contact with water. -Does not transmit shock, vibration, etc. -Keep away from strong electromagnetic interference sources.

### 3.2.2.2 Installation

The actual weight of myCobot collaborative robot is 800g. Considering the movement of the robot, the center of gravity will move as the robot moves. Therefore, the robot needs to be fixed on a solid base to be used normally.

**Interface size of robot base:** The pedestal fixing hole is the interface that fixes the robot to other bases or planes. The specific hole size is shown as following. It is 4 through holes with a diameter of 4.5mm, which can be fixed with M4 bolts.

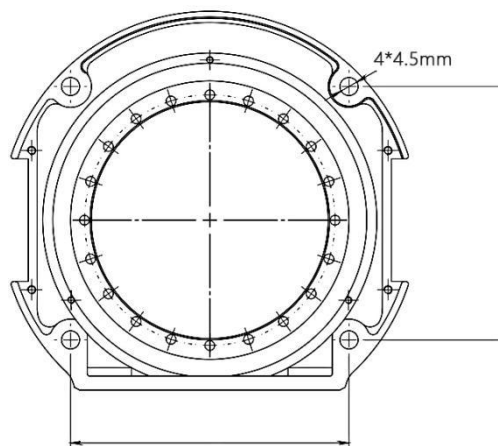

Make sure that there is a corresponding threaded hole on the fixed base before installing.

**Before you officially install, please confirm:**

- The environment to be installed complies with the requirements above.
- The installation position is not less than the working range of the robot, and there is enough space for installation, use, maintenance and repair.
- Place the stand in the proper position.
- Installation related tools are ready, such as screws, wrenches, etc.

After confirming the above, move the robot to the mounting surface of the base, adjust the position of the robot, and align the fixing hole of the robot base with the hole on the mounting surface of the base.

**Note:** When adjusting the position of the robot on the mounting base, please avoid pushing the robot directly on the mounting surface of the base to avoid scratches. When manually moving the robot, please try to avoid applying external force to the weak part of the robot body to avoid unnecessary damage to the robot.

### 3.3 Electronics and Electrical

myCobot has three external terminals. They are the external terminals of M5Stack Basic on the base, the two Grove terminals near the power socket and the external terminal pins of the M5Stack Atom J6 joint.

#### a) M5Stack Basic Electrical Diagram

	GND	1	2	ADC1	GPIO35
	GND	3	4	ADC2	GPIO36
	GND	5	6	RESET	EN
GPIO23	MOSI	7	8	DAC0/AUDIO_L	GPIO25
GPIO19	MISO	9	10	DAC1/AUDIO_R	GPIO26
GPIO18	SCK	11	12	3.3V	
GPIO3	IO0/RXD1	13	14	IO1/TXD1	GPIO1
GPIO16	IO2/RXD2	15	16	IO3/TXD2	GPIO17
GPIO21	IO4/SDA	17	18	IO5/SCL	GPIO22
GPIO2	IO6	19	20	IO7	GPIO5
GPIO12	IO8/IIS_SCLK	21	22	IO9/IIS_WS	GPIO13
GPIO15	IO10/IIS_OUT	23	24	IO11/IIS_MCLK/BOOT	GPIO0
	HPWR	25	26	ADC0/IIS_IN	GPIO34
	HPWR	27	28	5V	
	HPWR	29	30	BATTERY	

#### b) M5Stack Atom Circuit Diagram

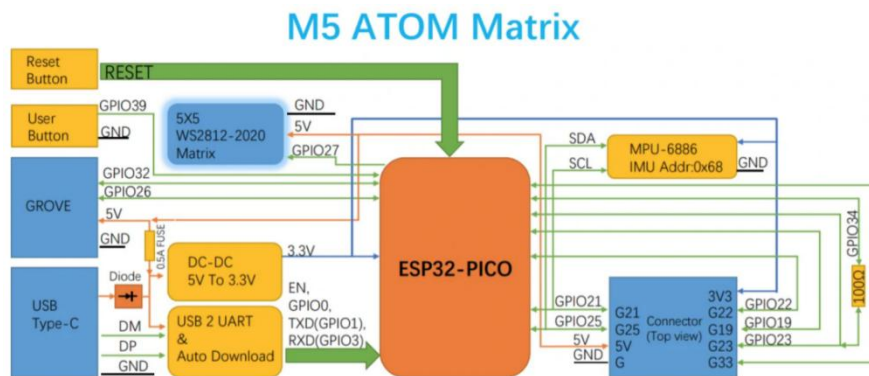

#### c) IO Interface Diagram

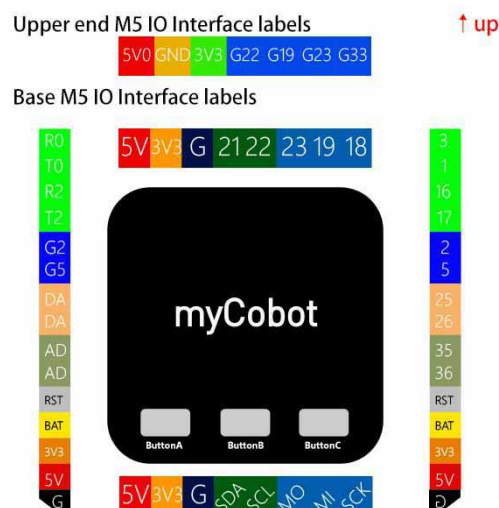



## 4. Software

For software updates, please check out our Github first.

<https://github.com/elephantrobotics/myCobot>

### 4.1 Built-in Track Recording

M5 Basic main control board has 3 buttons supporting custom programming and data writing.

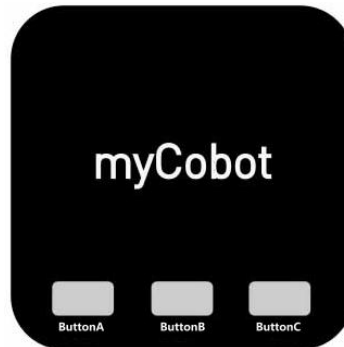

#### Drag Teaching Demonstration

1. **Recording:** After entering the recording mode, select the recording storage location

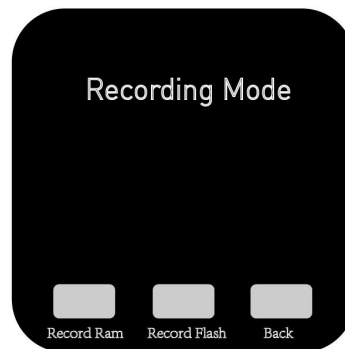

Button A: Store to Ram

Button B: Store to Memory Card

Button C: Exit the Recording Mode

2. **Start Recording**





After selecting the storage location, manually drag the robotic arm to complete the target action, then the action will be recorded and stored .

### 3、 Play



Button A: Start Playing the Recorded Action

Button B: Pause

Button C: Exit Playback

## 4.2 Arduino Libraries

A library is a collection of codes that allows you to easily connect and use sensors, displays, modules, etc. For example, the built-in LiquidCrystal library can realize easy communication with character LCD displays.

The functions of Arduino development board can be expanded when using the library. Because of the library, we can easily realize the collaboration between Arduino and external hardware or data communication. Arduino IDE is pre-installed with a series of standard library files. At the same time, you can also install and import third-party libraries (such as open source libraries downloaded from the Internet) into Arduino IDE. You can even create libraries and import them into Arduino IDE. The existence of the library helps users to bypass more specialized content such as registers and address pointers, greatly reducing the difficulty of development.

If you need to know how to add third-party libraries for the installation of ARDUINO IDE, please refer to the driver installation address and method:

[https://docs.m5stack.com/#/zh\\_CN/arduino/arduino\\_development](https://docs.m5stack.com/#/zh_CN/arduino/arduino_development)

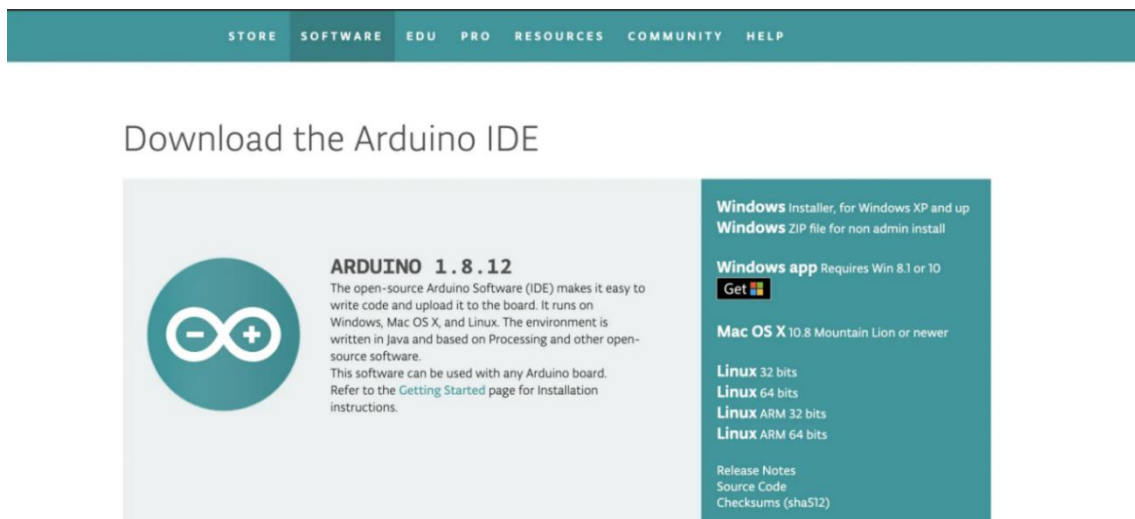

You can also check out our Github for more information.

<https://github.com/elephantrobotics/myCobot>

As follows:

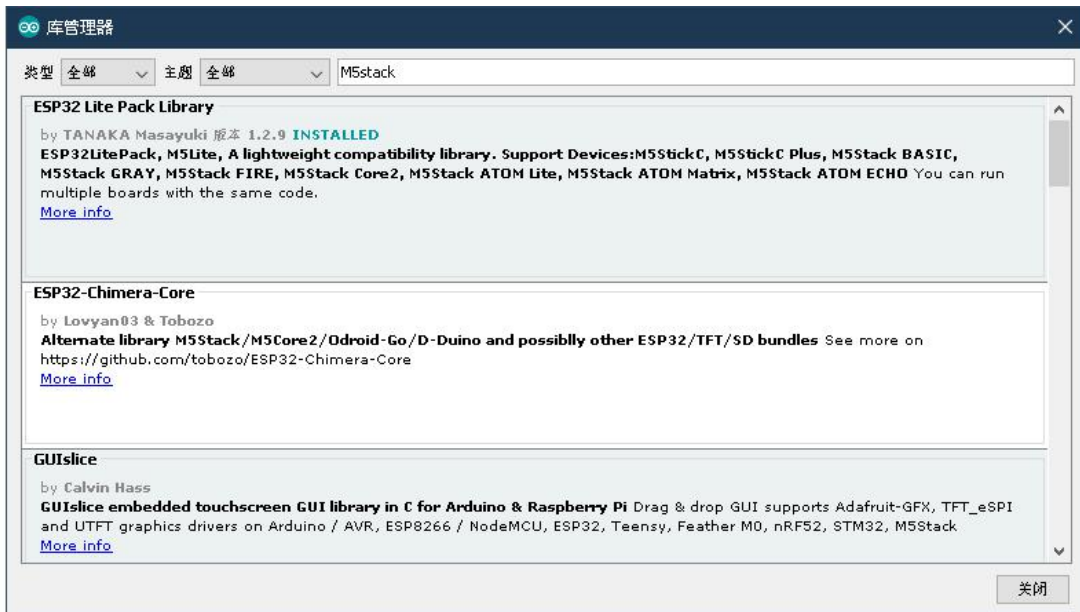

## 4.3 API Interface and Communication

- UIFLOW
- Arduino
- microPython
- FreeROTS

## 4.4 ROS

ROS is under development and will be updated according to the progress.

## 4.5 Joint Calibration

If your myCobot needs to calibrate joints, please use the firmware of myCobot or Arduino and other tools to burn Calibration first.

After uploading the firmware, the Basic interface is shown below:

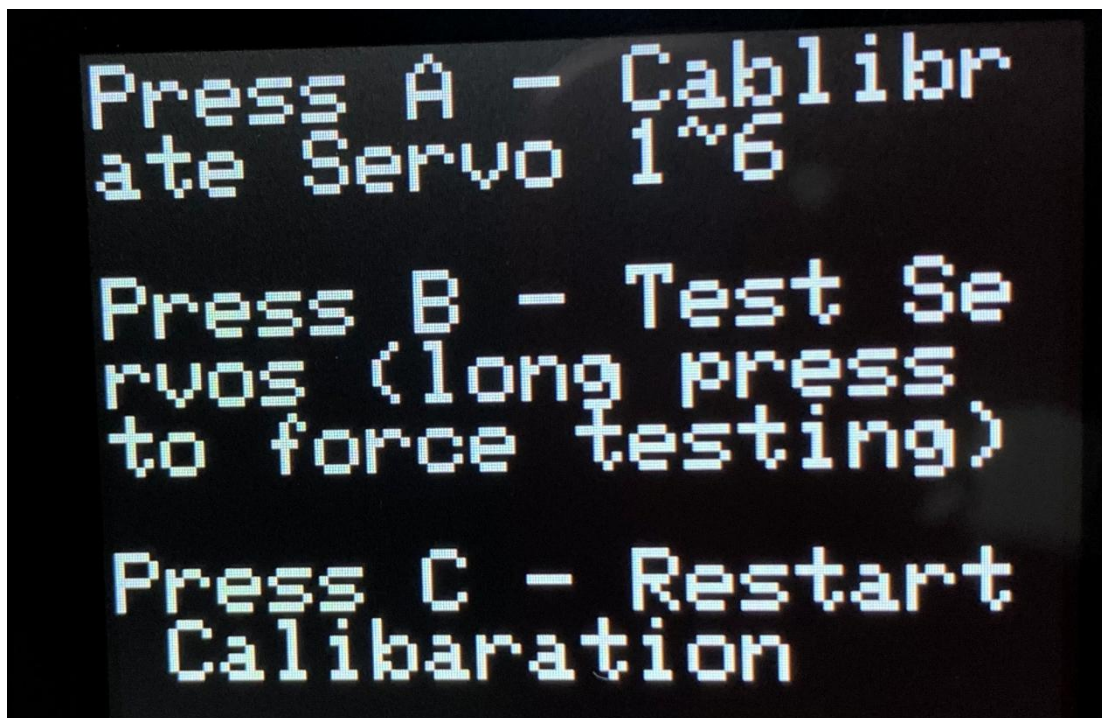

At this time, rotate J1 to the standard zero position aligning with the groove, and press the A button (the left button), then the J1 will go from a dynamic motion into a static position and be fixed to this standard zero position.

Repeat the steps following this method to set up the remaining J2-J6. After J6 is set, press the A key (the left key) again to save all the Settings.

When all joints are back to the standard zero position, you also need to check whether myCobot can operate normally. Press the B button (the middle button), then myCobot will detect J1 to J6 in sequence.

Please ensure that there are no obstacles or personnel interference within the operating range in order to prevent damage to equipment and personnel during testing.

## 4.6 Firmware Upgrade and Recovery

If you need to upgrade or maintain your myCobot, make sure that the development environment is set up. If not, please install the serial port driver first and then try to use the software.

The download link is as follows:

<https://github.com/elephantrobotics/myCobot/blob/main/Software/>

Choose “myCobot固件烧录器.zip” to download, then unzip into your project folder. Be careful not to use it with complex paths, which may lead to problems with unrecognized paths.

Contents of the unzipped folder are as follows:

CP210x_VCP_Windows	2020/11/30 15:23	文件夹	
ino	2020/11/25 17:36	文件夹	
esptool.exe	2020/11/25 11:07	应用程序	10,750 KB
list_ports.py	2020/9/17 17:49	Python 源文件	4 KB
logo.py	2020/11/24 14:05	Python 源文件	77 KB
myCobot.exe	2020/11/25 12:00	应用程序	39,627 KB
README.txt	2020/11/25 12:16	文本文档	1 KB

If you need to use this software, please read “README.txt” first.

If your development environment is already set up, you can directly open the file “myCobot.exe”.

After opening, the interface is as follows:



To upgrade or modify, follow these steps:

1. 选择终端 - Select terminal model
2. 选择串口 - Select serial port serial number
3. 选择文件 - Select the firmware version
4. Click “burn”

After burning:

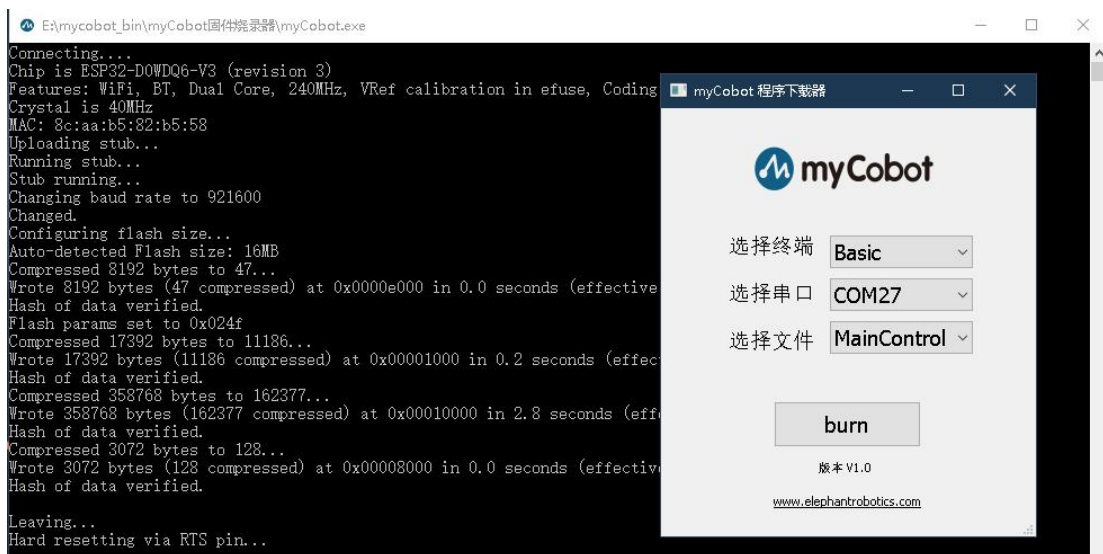

**Typical problems in software:**

## 1. Unable to select serial port



The reason is that the terminal is not connected well or the driver is not installed. Please reopen the software after checking the connection.

2. No port changes were detected after the replacement interrupt, so the upload could not be made. Please reopen the software.

## 5. Visual Programming and Industrial Software

### 5.1 Visual Programming Software-UIFlow

For detailed usage, please get the UI Flow operation manual from the link below.

**M5 Basic:** [https://docs.m5stack.com/#/zh\\_CN/quick\\_start/m5core/m5stack\\_core\\_get\\_started\\_MicroPython](https://docs.m5stack.com/#/zh_CN/quick_start/m5core/m5stack_core_get_started_MicroPython)

**M5 Atom:** [https://docs.m5stack.com/#/zh\\_CN/quick\\_start/atom/atom\\_quick\\_start UIFlow](https://docs.m5stack.com/#/zh_CN/quick_start/atom/atom_quick_start UIFlow)

### 5.2 Industrial Visualization Programming Software-RoboFlow

myCobot supports RoboFlow operating by Elephant Robotics industrial collaborative robots. The operation process of RoboFlow is simple and easy to use, and the interactive interface is clear and easy to understand, which is convenient for users to quickly master and use it, and effectively helps users to complete operations and programming tasks efficiently. Even novice users can also achieve target functions through simple operations.

**For detailed usage, please get the RoboFlow operation manual from the link below.**

<https://www.elephantrobotics.com/wp-content/uploads/2019/06/%E6%93%8D%E4%BD%9C%E4%B8%8E%E7%BC%96%E7%A8%8B%E6%89%8B%E5%86%8C-CN.pdf>

## 6. After-sales Service

- Return service is limited to goods not opened within 7 days after the receipt date of logistics of the products. The freight or other risks incurred in return shall be borne by the customer.
- Customers should provide the purchasing invoice and warranty card as the warranty certification when a warranty is being asked.

- Elephant Robotics will be responsible for the hardware faults of products caused by the normal using during the warranty period.
- The warranty period starts from the date of purchase or the receipt date of the logistics.
- The faulty parts from the products will be owned by Elephant Robotics, and the appropriate cost will be charged if necessary.

If you need to apply for warranty service, please contact our customer service first to confirm the detailed information. The following is warranty terms of detailed components:

**a) Sever motor****Warranty Period      Warranty Services**

≤1 months	Elephant Robotics offers a free new sever motor and bear the freight.
1-3 months	Elephant Robotics offers a free new sever motor, customs shall bear the freight.
≥3 months	Customers need to buy it themselves.

**b) Electrical Parts (M5 Hardware)****Warranty Period      Warranty Services**

≤3 months	Customers need to send it back after disassembly, Elephant Robotics shall send a new one for free and bear the freight out and home.
3-6 months	Customers need to send it back after disassembly and bear the freight out and home, Elephant Robotics shall send a new one for free.
≥6 months	Customers need to buy it themselves.

**c) Structure Parts****Warranty Period      Warranty Services**

≤3 months	Elephant Robotics offers free new components once, customs shall bear the freight.
≥3 months	Customers need to buy it themselves.

**d) Shell Parts****Warranty Period      Warranty Services**

a lifetime warranty	Elephant Robotics offers free new components once, customs shall bear the freight.
---------------------	--

During the warranty period of the delivered product, the company only repairs the malfunctions that occur during normal use of the robot for free. However, in the following cases, the customer will be charged for repairs (even during the warranty period):

- Damage or malfunction caused by incorrect use and improper use different from the contents of the manual.
- Failure caused by unauthorized disassembly by the customer.
- Damage caused by improper adjustment or unauthorized repairs.
- Damage caused by natural disasters such as earthquakes and floods.

Therefore, please strictly follow the instructions in this manual and related manual to operate the robot.



## 7. Q&A

**Q: The compiler could not find the corresponding device ?**

A: The device can be developed only after setting up the development environment and installing the corresponding project library.

**Q: The compiler could not compile the sample program properly find the corresponding device ?**

A: The required project library is not installed or there is a conflict with the project library. Please check that the project library is installed correctly first. If it is installed correctly but still cannot compile, please reinstall arduino development environment .

**Q: The Device failed to function properly after burning the firmware to ATOM ?**

A: The firmware for ATOM terminal needs to use our factory firmware. If any other firmware is accidentally burned, you can choose "myCobot固件烧录器-选择ATOM终端-选择串口-选择ATOMMAIN固件" to burn the ATOM terminal.

**Q: There is a slight wobble in the vertical position but not in the motion state ?**

A: Please check if myCobot is in a vertical state. myCobot is not affected by gravity in a vertical state, mechanical voidage can cause minor wobbles. But there will not be wobbles when it's out of the vertical state. The recommended speed is 400-500 in a vertical state.

**Q: Will the ROS system charge later ?**

A: ROS is open source and will be updated to our Github. There is no charge for firmware upgrades.

## 8. Contact Us

If you have any need for help, please contact us shown as following.

**Shenzhen Elephant Robotics Technology Co., Ltd**

Address: B7, Yungu Innovative Industrial Park 2, Nanshan, Shenzhen, China

Email: support@elephantrobotics.com

Phone: +86(0755)-8696-8565 (working day 9:30-18:30)

Website: www.elephantrobotics.com